

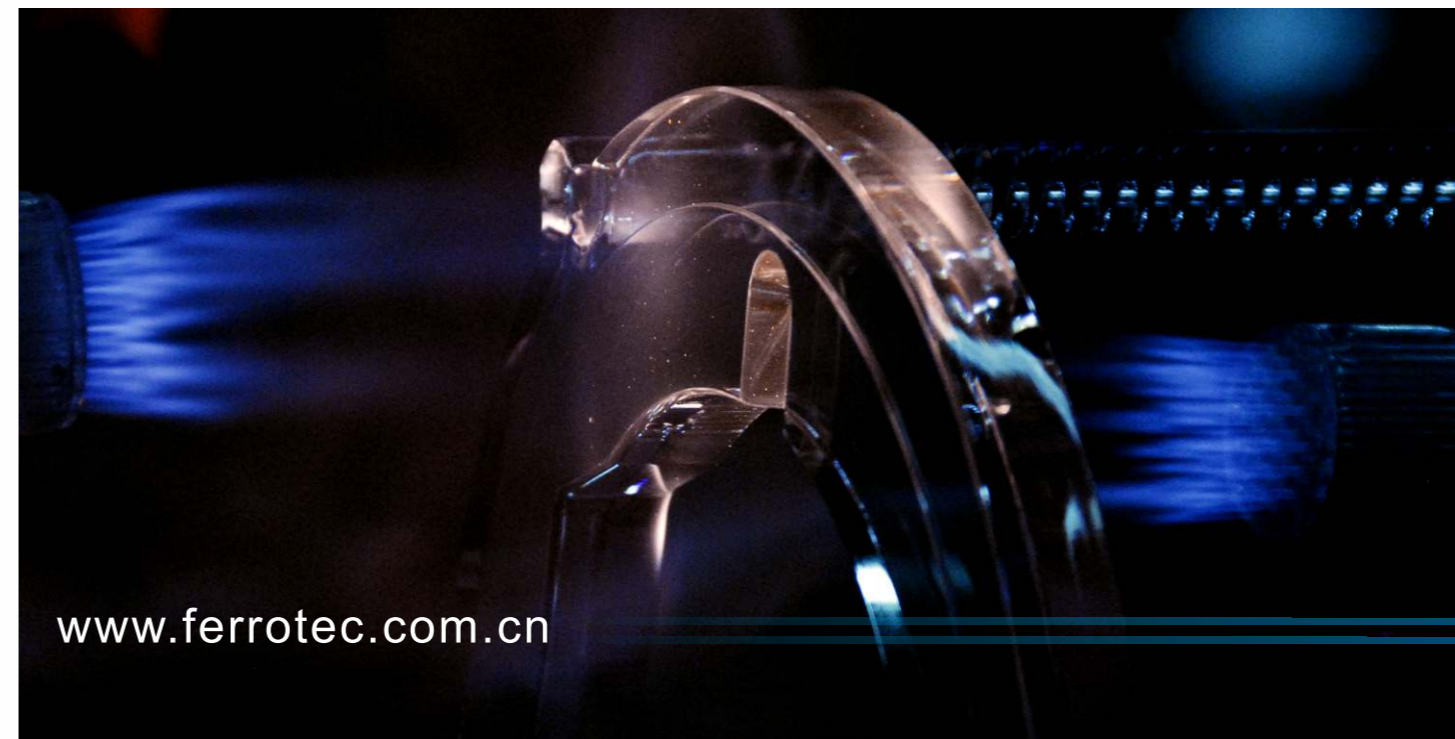

FerroTec



▲ 半导体设备生产商APPLIED、LAM、KE、TEL合格供应商证书  
Certificates of approved suppliers from APPLIED/LAM/KE/TEL (Semiconductor Equipment Manufactures)

FerroTec

中国地区

杭州大和热磁电子有限公司 (滨江一工厂—石英产品事业部)  
地址: 杭州市滨江区滨康路777号  
电话: (86)571-86698292  
传真: (86)571-86698293  
Email: quartz@ferrotec.com.cn  
邮编: 310053

www.ferrotec.com.cn

Quartz Products

石英产品

杭州大和热磁电子有限公司  
Hangzhou Dahe Thermo-Magnetics Co., Ltd.

# Quartz Products



明石海峡大桥石英模型

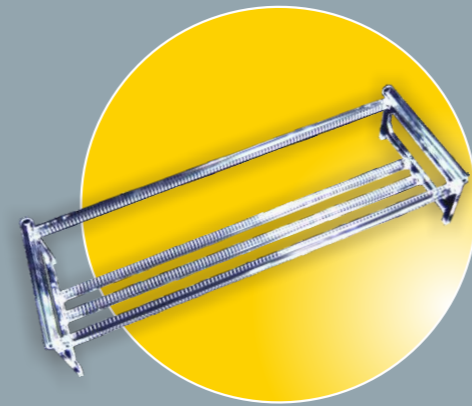
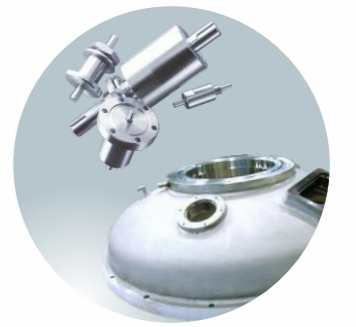
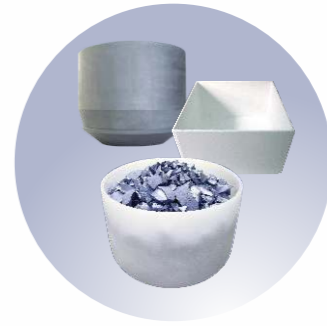
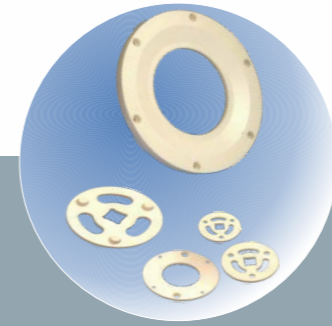

太阳能  
Solar Business

半导体/平板显示  
Semiconductor/FPD Business

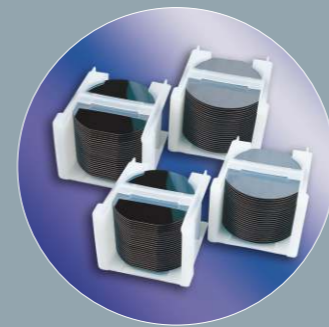

电子材料  
Electric materials Business

# FerroTec

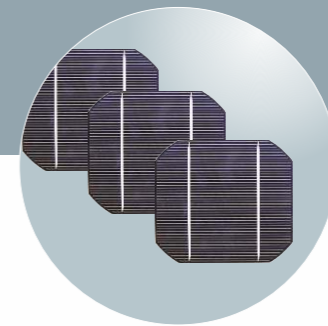

精密机械  
Precision Mechanics Business

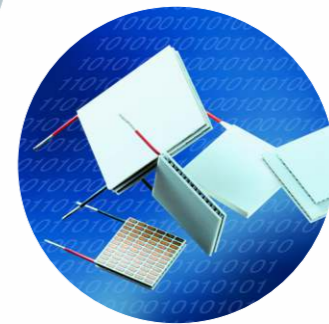

# 石英制品 · 半导体产业的支柱

## Quartz Products Vital to the Semiconductor Industry

杭州滨江一工厂 Hangzhou Binjiang 1Fab



投资金额超过6500万人民币，拥有从日本和美国引进的各种先进加工设备，10000级净空化学洗净室和检查室，以及用于超真空装置用石英零件洗净的100级超净空房。可批量生产12”、8”、以及8”以下半导体装置用石英制品。

With a total investment of over 65 million RMB, the division is equipped with many advanced machines imported from Japan and USA. The division also has chemical cleaning and final inspection areas located inside the class 10,000 cleanroom. In addition, it has a class 100 cleanroom to meet the needs of today's stringent requirements. The division specializes in producing quartz parts for 12 inch, 8 inch or smaller semiconductor applications.

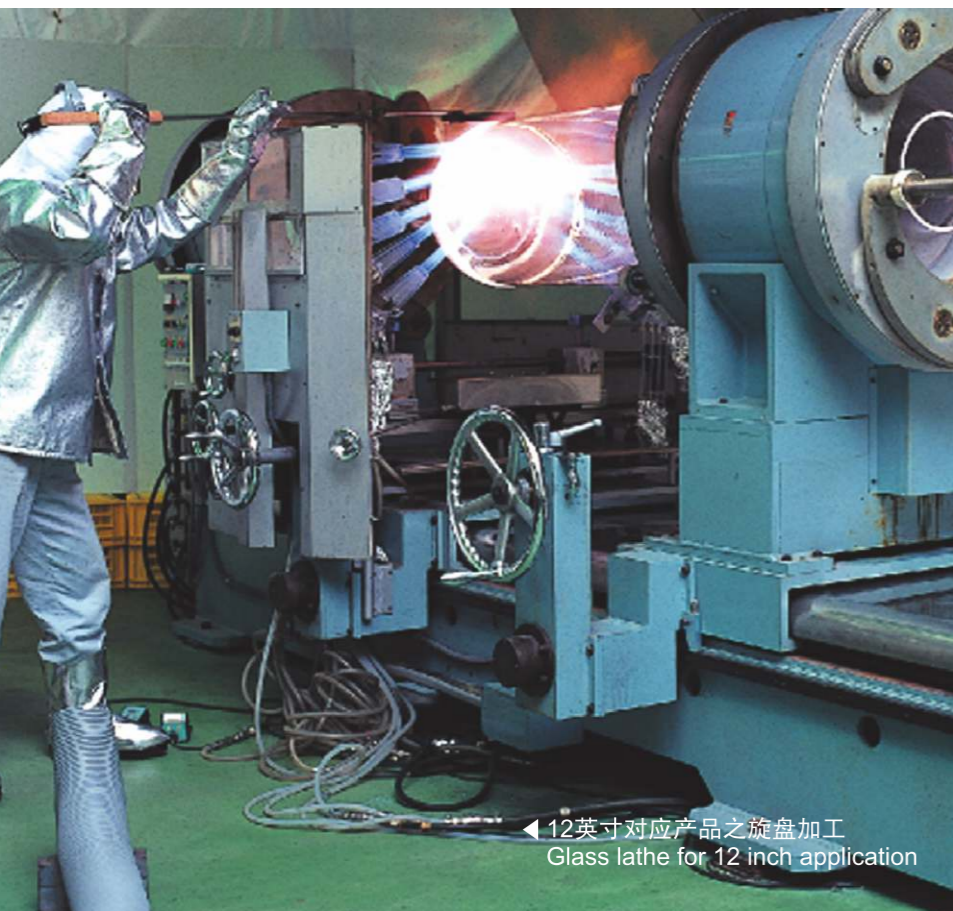

12英寸对应产品之旋盘加工  
Glass lathe for 12 inch application



▲ 激光切割  
Laser cutting



▼ 加工中心  
Machine center

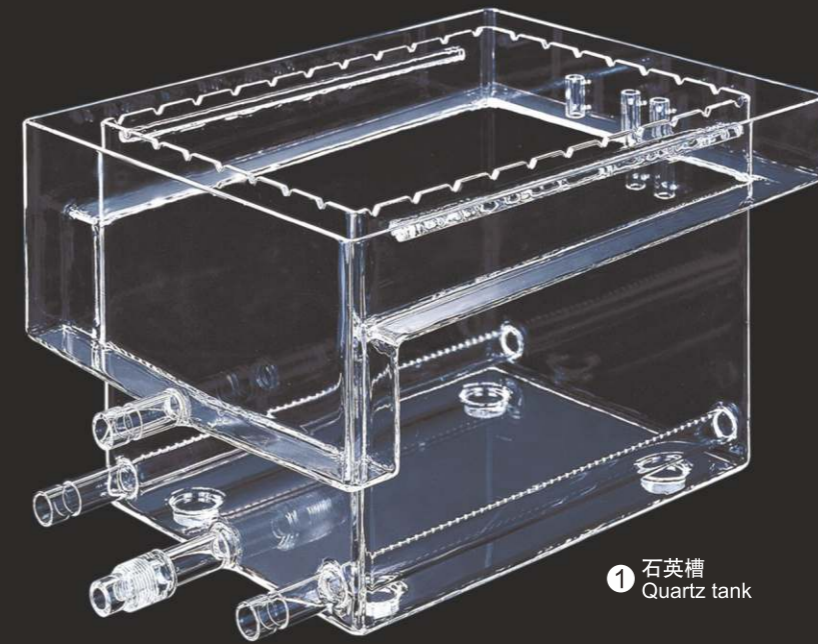

1 石英槽  
Quartz tank



2 翅片保温筒  
Quartz fin pedestal



3 横型石英舟  
Horizontal quartz boat

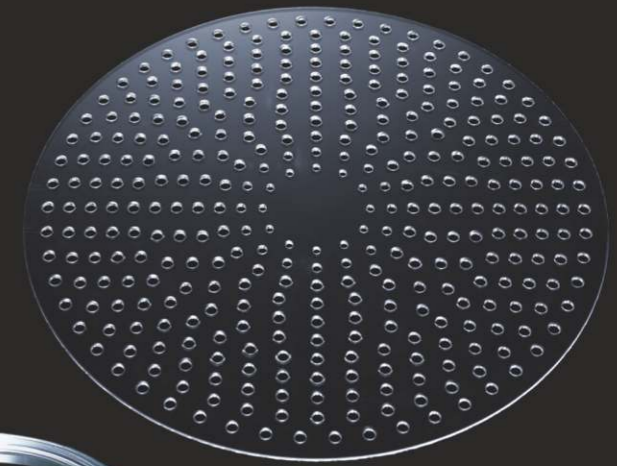

4 精密机械加工部品  
Precision machined part



5 立式反应管  
Horizontal reaction tube



6 立式石英舟  
Vertical quartz boat



# 石英制品 · 太阳能产业的耗材

## Quartz Products Consumed in the Solar PV Industry

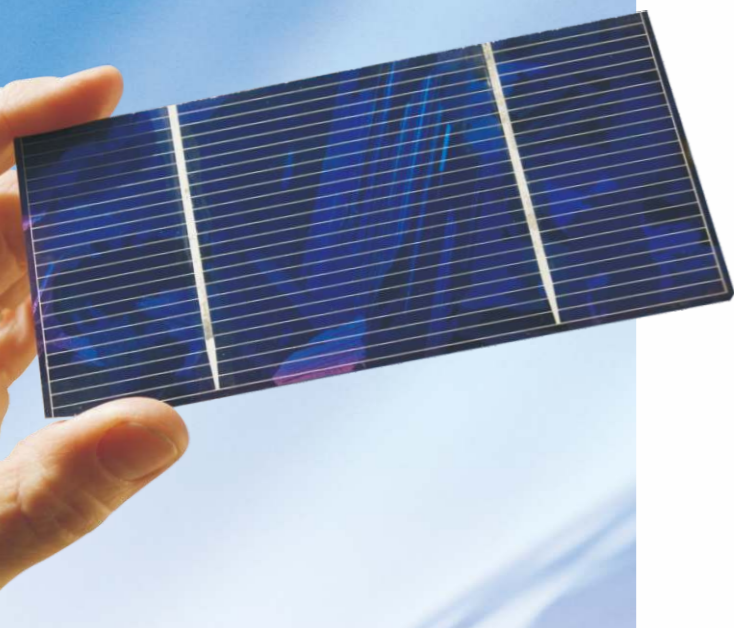

公司是专注于品质的日资上市企业，拥有半导体先进的石英生产工艺，对太阳能产品的生产具有绝对的可控性及可追溯性。公司现有的客户遍布中国大陆。

Equipped with advanced quartz manufacturing techniques for semiconductor equipments, Ferrotec Hangzhou, a Japanese listed company, highly valuing the quality, has absolute controllability and traceability for solar quartz products. We are now approved supplier for many mainland solar PV companies.



▶ 火加工现场一  
Firework Shop 1



▶ 火加工现场二  
Firework Shop 2



▶ 检查室  
Inspection Room



▶ 百级纯水洗净室  
Class 100 Cleanroom for DI Water Cleaning

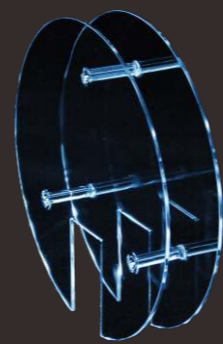

◀ 挡热块  
Thermal Block



◀ 源瓶、清洗瓶  
Cleaning bottle

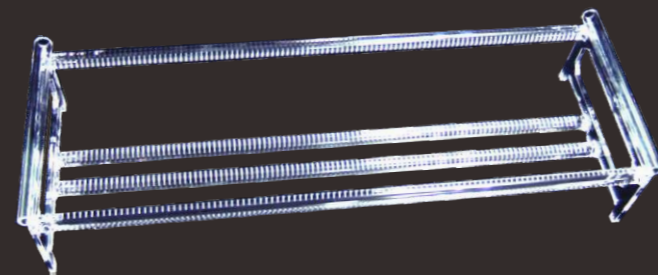

▲ 石英(晶)舟  
Quartz boat



▲ 废液瓶  
Waste solutions bottle

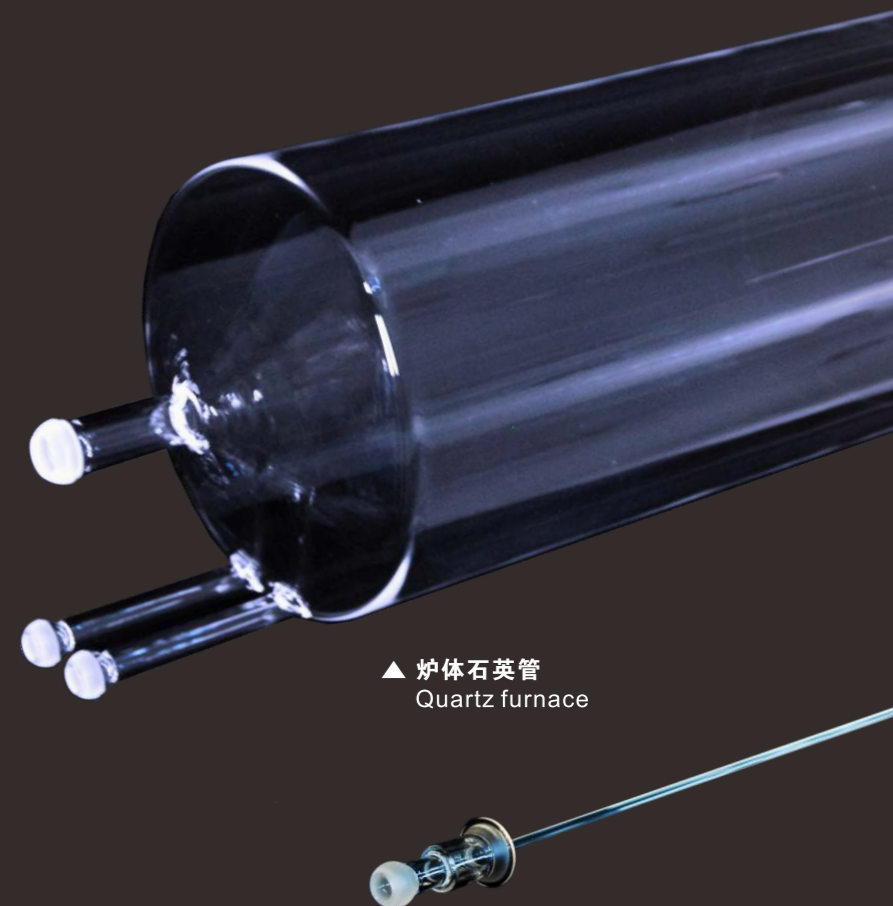

▲ 炉体石英管  
Quartz furnace

▲ 尾气管  
Exhaust Pipe



◀ 石英炉门  
Quartz door

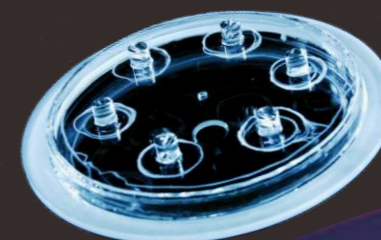

◀ 隔热包  
Heat-insulating block

太阳能行业部分石英产品  
Quartz products in PV industry